

DRD5S & SurfaceFrame Alt/EM

8" Round Surface Mount LED Area Light







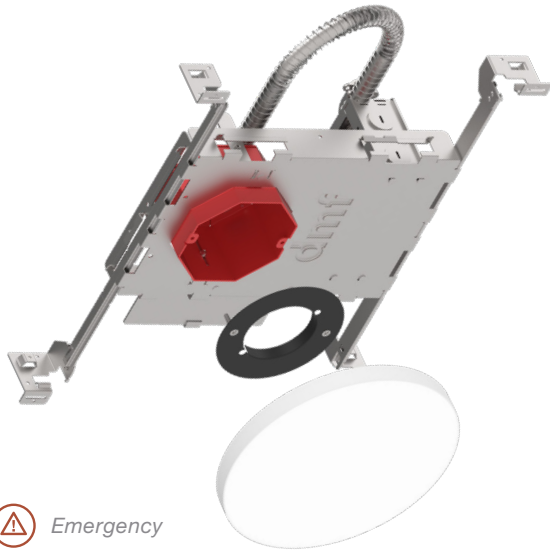

Alternate Dimming and/or Emergency Lighting
DRDHNJO Octagonal Junction Box

Project:	Type:
Product Code:	Date:

Spec Sheet V-04.15.19



- Maintains all the standard SurfaceFrame ratings
- Offers enhanced dimming protocol compatibility including Lutron Hi-Lume® 1%
- Can provide lighting for more than 90 minutes after power failure - enough to meet common safety regulations like NFPA 101
- 8" round area light for lighting smaller spaces including bathrooms, closets and kitchens

Application New Construction		Aperture 4" Octagonal Junction Box	
Delivered Lumens 1500 lm (17W)		Color Quality 90+ CRI, < 3-step SDCM	
Color Temperature  2700K 3000K 3500K		Input Voltage 120/277V	
Emergency Lighting Emergency LED Driver for lighting up to 90 minutes in event of power failure			
Shape 8" Round		Finish White	
Housing Ratings  Code compliant for use in appropriate fire-rated assemblies up to a maximum of 2-hours  STC/IIC Sound Rated  ASTM E283 Certified Air Tight  IC (Insulation Contact) Rated			Module Ratings  UL Listed for Wet Location
Standards   		Guarantee 50,000 hrs 5 years	Additional Options TRIAC/ELV Dimming



DRD5S & SurfaceFrame Alt/EM

8" Round Surface Mount LED Area Light

Alternate Dimming and/or Emergency Lighting

DRDHNJO Octagonal Junction Box

PRODUCT BUILDER

ALTERNATE DIMMING / EM HOUSING

PRODUCT CODE		APPLICATION		APERTURE		DRIVER		OPTION	
DRDH	Housing	N	New Construction	JO	Octagonal Junction Box	15OS	0-10V ¹ , 1500 lm	[Blank]	None
						15CS	Lutron LDE1 ² , 1500 lm	EMS	EM Driver, Remote Test Switch
						15LS	Lutron LTEA2W ³ , 1500 lm		

LED MODULE

PRODUCT CODE		DIMENSION		SHAPE		LUMENS		CRI		CCT		DRIVER	
DRD5S	Module	8	8" Diameter	R	Round	15	1500 lm	9	90+ CRI	27	2700K	A	Alternate
										30	3000K		
										35	3500K		

¹ Only applicable to EM Driver option

² Lutron LDE1 refers to Lutron Hi-lume 1% EcoSystem LED driver with Soft-on, Fade-to-Black™

³ Lutron LTEA2W refers to Lutron Hi-lume 1% 2-wire LED driver



DRD5S & SurfaceFrame Alt/EM

8" Round Surface Mount LED Area Light

Alternate Dimming and/or Emergency Lighting

DRDHNJO Octagonal Junction Box

HOUSING

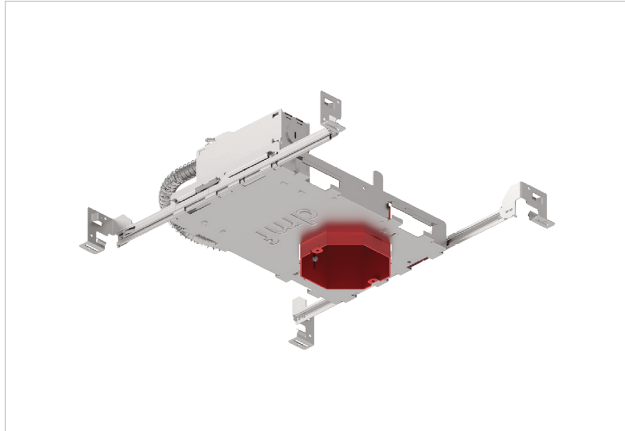

SurfaceFrame

Octagonal Junction Box with Alternate Dimming and/or Emergency Lighting

DRDHNJO

SUMMARY

JUNCTION BOX: Equipped with (4) 1/2" trade size knockouts (two side, two top) to allow straight conduit runs. Approved for 6 (three in, three out) #12 AWG 70°C through wiring conductors.

MOUNTING: Pre-installed mounting brackets allow vertical adjustment of bar hangers up to 1"

CEILING: 1/2" up to 1 3/4"

CUTOUT: 4 1/8" (105mm) octagonal opening

INPUT VOLTAGE: 120/277V

MAX INPUT CURRENT (120V): 0.15 amps

MAX INPUT CURRENT (277V): 0.06 amps

POWER FACTOR: Greater than 0.9

TOTAL HARMONIC DISTORTION: Less than 20%

LISTINGS: Metallic outlet box certified UL514A, code compliant for use in appropriate fire-rated assemblies for up to 2-hours, STC/IIC Sound Rated, ASTM E283 certified Air Tight, IC (Insulation Contact) rated

WARRANTY: 5 year limited warranty

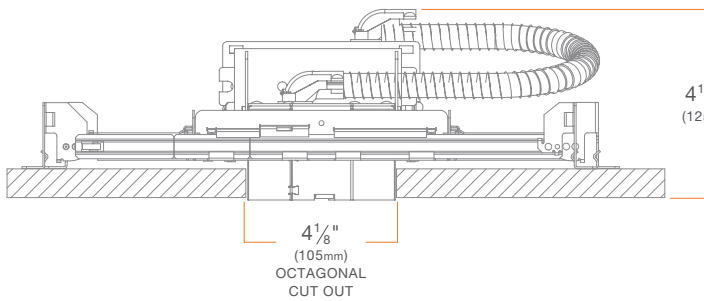

4 15/16" (125mm)

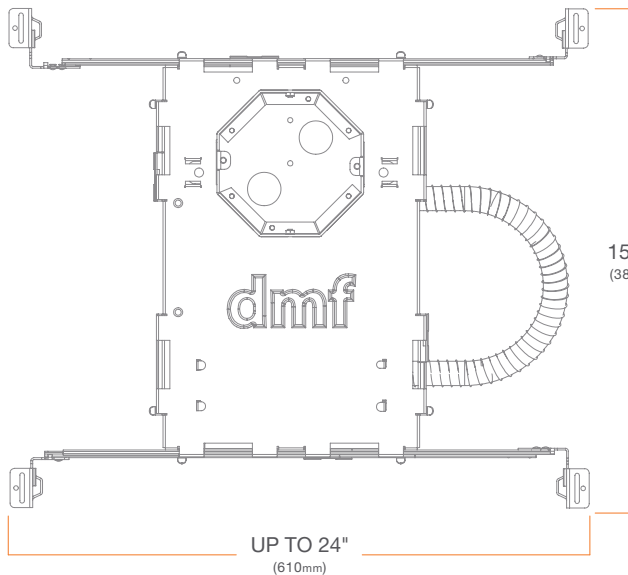

15 1/16" (383mm)



DRD5S & SurfaceFrame Alt/EM

8" Round Surface Mount LED Area Light

Alternate Dimming and/or Emergency Lighting
DRDHNJO Octagonal Junction Box

MODULE



DRD5S

8" Round Surface Mount LED Module

DRD5S

SUMMARY

LED: Samsung optimized LED array

SHAPE: 8" round

MODULE LUMENS: 1500 lm (17W)

COLOR QUALITY: 90+ CRI, less than 3-step SDCM

CCT: 2700K, 3000K, 3500K

DIMMING: 0-10V, Lutron Hi-lume® 1%

AMBIENT OPERATING TEMPERATURE: -20°C to 40°C

PHOTOMETRIC TESTING: Tested in accordance to IESNA LM-79-2008

TRIM: Edgeless die-cast aluminum

LISTINGS: ENERGY STAR® qualified, California Title 24 2016 JA8 compliant, UL Listed for Wet Location, cULus Listed

LIFETIME: 50,000 hours at 70% lumen maintenance

WARRANTY: 5 year limited warranty

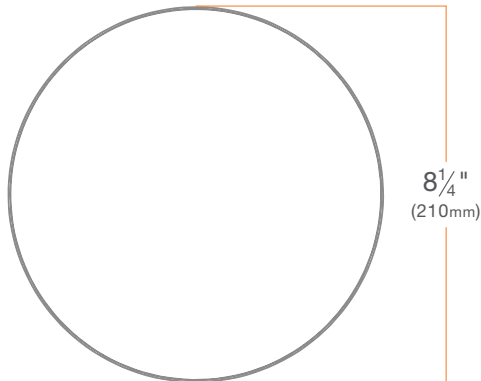
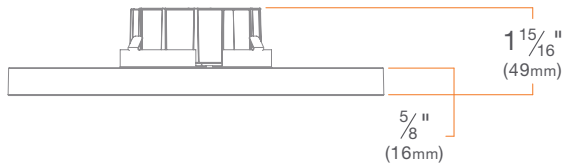



DRD5S & SurfaceFrame Alt/EM

8" Round Surface Mount LED Area Light

Alternate Dimming and/or Emergency Lighting

DRDHNJO Octagonal Junction Box

PHOTOMETRY

DRD5S 8" Round, 1500 lm, 90 CRI, 3000K **DRD5S8R15930**

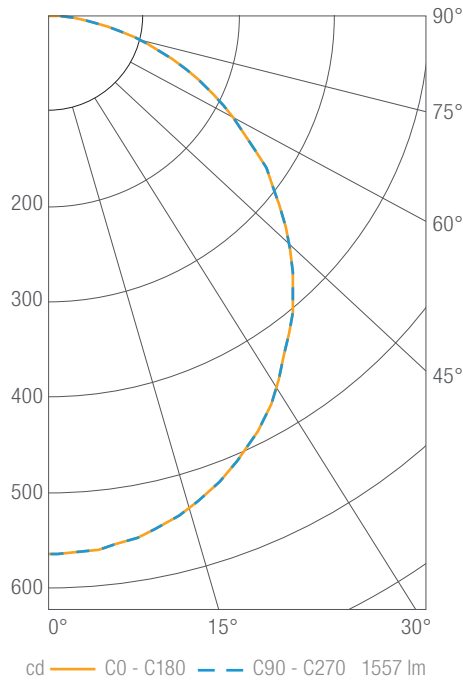

Luminous Intensity

Gamma	C 0°
0°	567
5°	564
10°	556
15°	542
20°	523
25°	499
30°	469
35°	433
40°	400
45°	360
50°	318
55°	279
60°	232
65°	189
70°	145
75°	100
80°	57
85°	25
90°	2

Values in candela

Zonal Lumen Summary

Zone	Lumens	Luminaire %
0-30	436	28
0-40	708	46
0-60	1234	79
0-90	1557	100
0-180	1557	100

Illuminance Chart

Distance from LED	Foot Candles	Diameter
3.0'	63	8.4'
6.0'	16	16.8'
9.0'	7	25.1'
12.0'	4	33.5'

Beam Angle: 110°



DRD5S & SurfaceFrame Alt/EM

8" Round Surface Mount LED Area Light

Alternate Dimming and/or Emergency Lighting

DRDHNJO Octagonal Junction Box

DIMMER COMPATIBILITY

Recommended Phase-control Dimmers (Dims down to 5% nominal measured light output)

Brand	Series	Model Number	Max Load
Cooper	Aspire	9573	17
Leviton	Vizia	VPE06	35
Lutron	CL Series	AYCL-253, DVCL-253	15
	Grafik Eye 3000	QSGR-3P, QSGR-6P	17
	Grafik Sys / Homeworks	RPM-4U	26
	Maestro CL	MACL-153M, MSCL-OP153M, MSCL-VP153M	9



SurfaceFrame Options

Shallow Recessed LED Downlight

DRD2 & SurfaceFrame

DRDHNJO Octagonal Junction Box

DRD2 & SurfaceFrame Alt/EM

Alternate Dimming and/or Emergency Lighting

DRDHNJO Octagonal Junction Box

Apex Series Shallow Recessed LED Downlight

DRD2X & SurfaceFrame

DRDHNJO Octagonal Junction Box

DRD2X & SurfaceFrame Alt/EM

Alternate Dimming and/or Emergency Lighting

DRDHNJO Octagonal Junction Box

Surface Mount LED Downlight

DRD5S & SurfaceFrame

DRDHNJO Octagonal Junction Box

DRD5S & SurfaceFrame Alt/EM

Alternate Dimming and/or Emergency Lighting

DRDHNJO Octagonal Junction Box