

DCC







LED Cylinder

Project:	Type:
Product Code:	Date:

CUSTOM



- Customize your cylinder with over one million configurations
- Powered by DMF's advanced LED downlight technology
- Modular Twist & Lock trims and Plug & Play light engines for easy maintenance and on-site modifications
- Shadowless pendant uplight allows for direct and indirect lighting from a single cylinder
- Die-cast aluminum with no visible hardware for a sleek, symmetrical design

<p>Lumen Output 400 lm (12.0W)</p>	<p>Mount Surface, Cord, Stem, Wall</p>
<p>Wavelength > 560 nm</p>	<p>Size Diameter: 4" Length: Small (4"), Medium (8"), Large (12")</p>
<p>Color Temperature</p>  <p>Turtle Friendly</p>	<p>Finish White, Black, Brushed Aluminum, Bronze, Custom Color</p> <p>Stem/Cord Length 24" or 48" (standard), Up to 96" (custom)</p>
<p>Lighting Type</p>    <p>Downlight Uplight Up and downlight</p>	<p>Optics</p>  <p>General Ambient (90°)</p>
<p>Input 120/277V</p>	<p>Dimming TRIAC/ELV 5%, 0-10V 1%, Lutron Hi-lume® 1%</p>
<p>Emergency Lighting Optional Remote Inverter or Emergency LED Driver for lighting up to 90 minutes in event of power failure</p>	<p>Trims and Shades Round Beveled Trim, Hyperbolic Trim, Snoot, Decorative Trim, Low-Profile Decorative Trim, Round Shade, Flat Shade</p>
<p>Ratings</p>  <p>Wet location available</p>	<p>Guarantee 50,000 hrs 5 years</p>



PRODUCT BUILDER

CYLINDER	<input type="checkbox"/>	DCC Cylinder			
MOUNT	<input type="checkbox"/>	C2 Cord Mount, 24"	C4 Cord Mount, 48"	CC Cord Mount, Custom	
		T2 Stem Mount, 24"	T4 Stem Mount, 48"	TC Stem Mount, Custom	
		SM Surface Mount	WM Wall Mount ¹		
CYLINDER OPTION	<input type="checkbox"/>	S Standard (Damp Location)	W Wet Location ²		
LENGTH	<input type="checkbox"/>	S Small (4")	M Medium (8")	L Large (12")	
DIAMETER	<input type="checkbox"/>	4 4" Diameter			
LIGHT OPTIONS	<input type="checkbox"/>	D Down/Uplight			
LUMENS DOWN	<input type="checkbox"/>	04 400 lm			
OPTICS DOWN	<input type="checkbox"/>	G General Ambient (90°+)			
SPECIALTY LENS OPTIONS DOWN	<input type="checkbox"/>	0 None			
LUMENS UP³	<input type="checkbox"/>	00 None	04 400 lm		
OPTICS UP³	<input type="checkbox"/>	0 None	G General Ambient (90°+)		
CCT	<input type="checkbox"/>	TF Turtle Friendly			
FINISH	<input type="checkbox"/>	W White	B Black	A Brushed Aluminum	
		Z Bronze	C Custom Color		
DRIVER	<input type="checkbox"/>	T TRIAC/ELV (5%)	O 0-10V(1%) ¹	C Lutron LDE1 EcoSystem (1%) ¹	
		L Lutron LTEA2W 2-Wire (1%) ¹			
SPECIALTY OPTIONS	<input type="checkbox"/>	00 None	E1 EM, Remote Test Switch		
TRIM / SHADE DOWN	<input type="checkbox"/>	R Round Beveled Trim	H Hyperbolic Trim	S Snoot	D Decorative Trim
		L Low Profile Decorative Trim	RWC Round Shade: White, Clear ⁴	RWW Round Shade: White, Warm ⁴	RBC Round Shade: Black, Clear ⁴
		RBW Round Shade: Black, Warm ⁴	RAC Round Shade: Aluminum, Clear ⁴	RCC Round Shade: Custom Color ⁴	FWC Flat Shade: White, Clear ⁴
		FWW Flat Shade: White, Warm ⁴	FBC Flat Shade: Black, Clear ⁴	FBW Flat Shade: Black, Warm ⁴	FAC Flat Shade: Aluminum, Clear ⁴
		FCC Flat Shade: Custom Color ⁴			
TRIM / SHADE UP⁵	<input type="checkbox"/>	[Blank] N/A	R Round Beveled Trim	H Hyperbolic Trim	
		S Snoot	D Decorative Trim	L Low Profile Decorative Trim	

¹ Only available in Medium or Large size

² Only available with Round Beveled or Decorative Trim; Not available in Adjustable or Cord Mount

³ Only applicable to Large size, Cord, Stem or Wall mounts; Otherwise, select None; Not available with EM

⁴ Not available in Wall Mount

⁵ Only applicable to Wall Mount Up and Downlight, Cord and Stem Mount Uplight utilize specialty trim



PRODUCT BUILDER

ACCESSORIES

DCCX-CC	Custom Length Cord Mount (up to 96")
DCCX-TC	Custom Length Stem Mount (up to 96")
DCCX-RW	Round Beveled Trim, White
DCCX-RB	Round Beveled Trim, Black
DCCX-RA	Round Beveled Trim, Brushed Aluminum
DCCX-RZ	Round Beveled Trim, Bronze
DCCX-RC	Round Beveled Trim, Custom
DCCX-HW	Hyperbolic Trim, White
DCCX-HB	Hyperbolic Trim, Black
DCCX-HA	Hyperbolic Trim, Brushed Aluminum
DCCX-HZ	Hyperbolic Trim, Bronze
DCCX-HC	Hyperbolic Trim, Custom
DCCX-S	Snoot
DCCX-D	Decorative Trim
DCCX-L	Low-Profile Decorative Trim
DCCX-RWC	Round Shade: White Outside, Clear Diffused Inside
DCCX-RWW	Round Shade: White Outside, Warm Diffused Inside
DCCX-RBC	Round Shade: Black Outside, Clear Diffused Inside
DCCX-RBW	Round Shade: Black Outside, Warm Diffused Inside
DCCX-RAC	Round Shade: Brushed Aluminum Outside, Clear Diffused Inside
DCCX-RCC	Round Shade: Custom Color
DCCX-FWC	Flat Shade: White Outside, Clear Diffused Inside
DCCX-FWW	Flat Shade: White Outside, Warm Diffused Inside
DCCX-FBC	Flat Shade: Black Outside, Clear Diffused Inside
DCCX-FBW	Flat Shade: Black Outside, Warm Diffused Inside
DCCX-FAC	Flat Shade: Brushed Aluminum Outside, Clear Diffused Inside
DCCX-FCC	Flat Shade: Custom Color

PRODUCT SUMMARY



Large, black, stem
mount shown

SUMMARY

LED: Cree® Red-Orange LED (no color filter)

DELIVERED LUMENS: 400 lm (12.0W)

WAVELENGTH: > 560 nm

DIMMING: Down to less than 5% for TRIAC/ELV at 120V, 1% for 0-10V or Lutron Hi-lume® 1% at 120/277V

INPUT VOLTAGE: 120/277V, 50/60Hz

MAX INPUT CURRENT (120V): 0.11 amps

MAX INPUT CURRENT (277V): 0.047 amps

POWER FACTOR: Greater than 0.9

TOTAL HARMONIC DISTORTION: Less than 20%

AMBIENT OPERATING TEMPERATURE: -20°C to 40°C

EMERGENCY LIGHTING: Optional installer mounted Remote Inverter or Emergency LED Driver for lighting up to 90 minutes in event of power failure

PHOTOMETRIC TESTING: Tested in accordance to IESNA LM-79-2008

LISTINGS: UL Listed for Wet Location (option), cULus Listed, Florida Fish and Wildlife Conservation Commission compliant

LIFETIME: 50,000 hours at 70% lumen maintenance

CYLINDER: Extruded aluminum; 4" (small), 8" (medium), 12" (large)

FINISH: White, Black, Bronze, Brushed Aluminum, Custom Color

PENDANT: 24" or 48" standard, custom length available up to 96". Cord: White, black or silver with round canopy. Stem: Painted steel stem with round canopy and hanging straight endpoint with up to 30° tilt (meets CA IR 16-9).

MOUNT: Surface, Cord, Stem: Installs in most 3" octagonal, 4" octagonal, 3" round and 4" round boxes. Wall Mount: Installs in most one-gang switch boxes. Wet Location Wall Mount: Installs in most two-gang switch, 3" octagonal, 4" octagonal, 3" round, 4" round and 4" square boxes.

WARRANTY: 5 year limited warranty

CYLINDER DIMENSIONS

**Surface Mount
LED Cylinder**

DCCSM

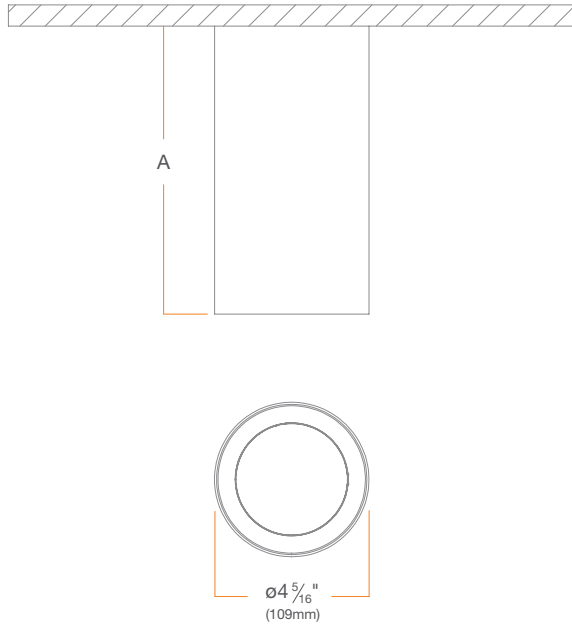

**Cord Mount
LED Cylinder**

DCC2CM

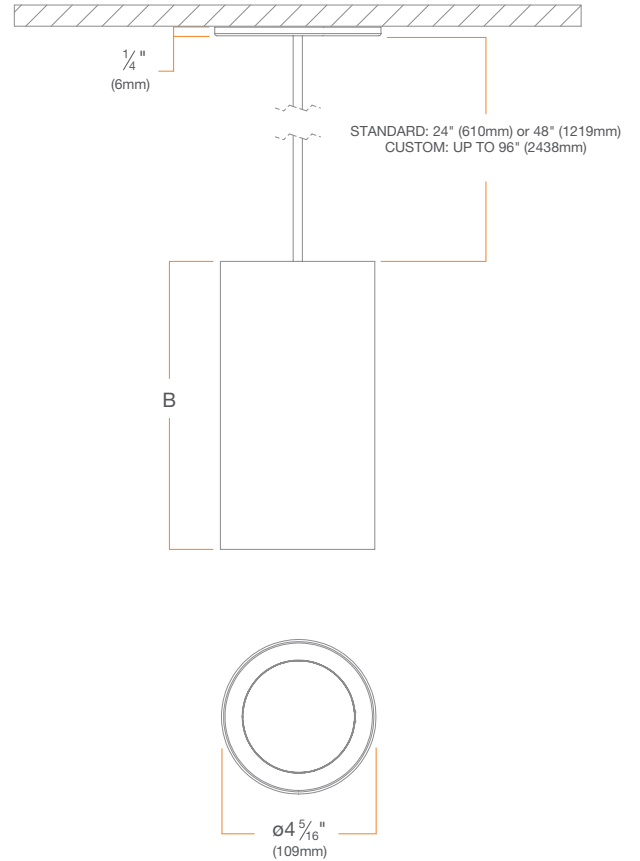

CYLINDER SIZE	A
Small	4" [102 mm]
Medium	8" [203 mm]
Large	12" [305 mm]

CYLINDER SIZE	B
Small	4" [102 mm]
Medium	8" [203 mm]
Large	12" [305 mm]

CYLINDER DIMENSIONS

**Stem Mount
LED Cylinder**

DCC2TM

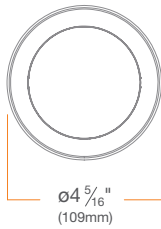
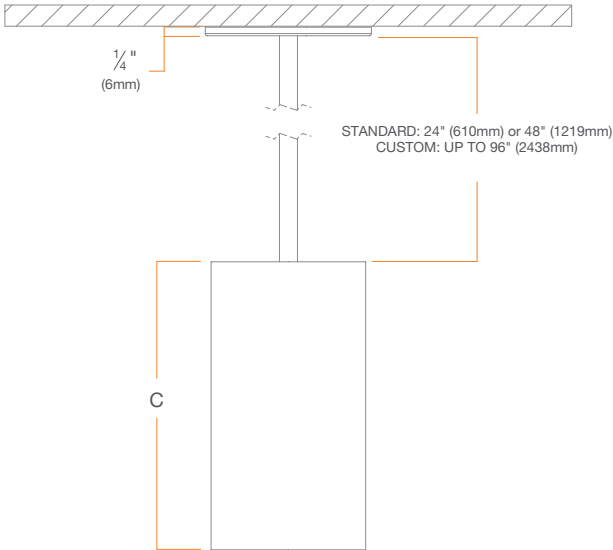

**Stem Mount, Wet Location
LED Cylinder**

DCC2TM

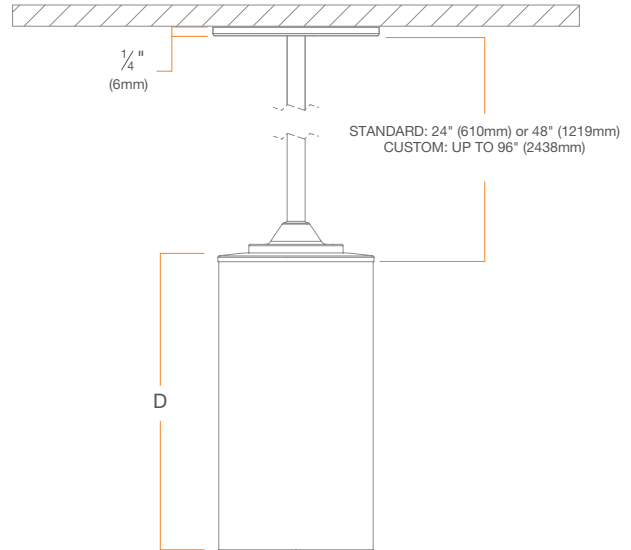

CYLINDER SIZE	C
Small	4" [102 mm]
Medium	8" [203 mm]
Large	12" [305 mm]

CYLINDER SIZE	D
Small	4 1/4" [108 mm]
Medium	8 1/4" [210 mm]
Large	12 1/4" [311 mm]

CYLINDER DIMENSIONS

Wall Mount Downlight
LED Cylinder

DCC2WM

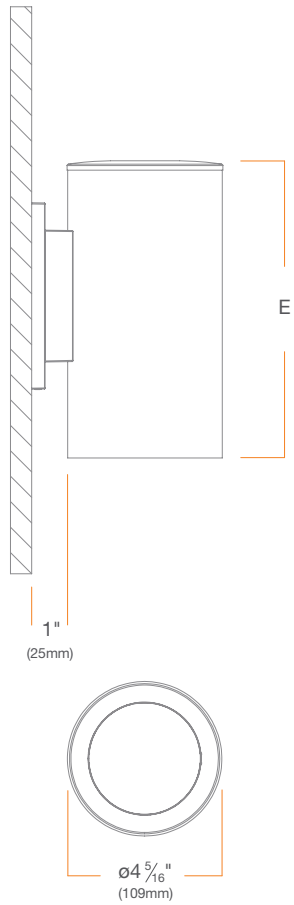

Wall Mount Downlight,
Wet Location LED Cylinder

DCC2WM

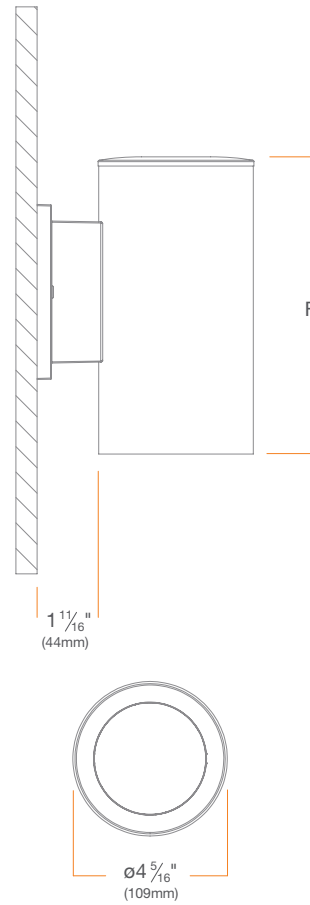

CYLINDER SIZE	E
Medium	8 1/4" [210 mm]
Large	12 1/4" [311 mm]

CYLINDER SIZE	F
Medium	8 1/4" [210 mm]
Large	12 1/4" [311 mm]

CYLINDER DIMENSIONS

**Wall Mount Up and Downlight
LED Cylinder**
DCC2WM

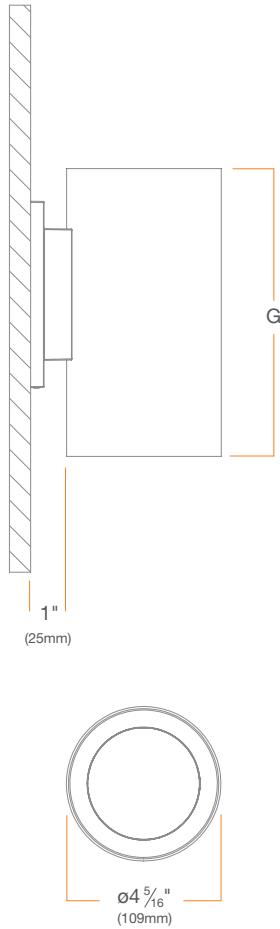

**Decorative
Trim**
DCCX-D

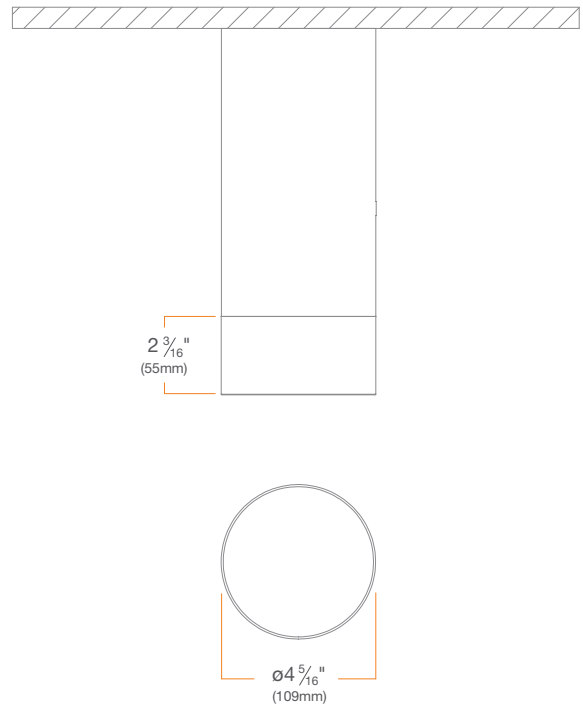

CYLINDER SIZE	G
Medium	8" [203 mm]
Large	12" [305 mm]

CYLINDER DIMENSIONS

**Low-Profile
Decorative Trim**
DCCX-L

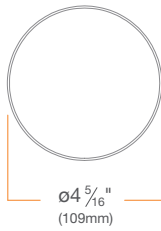
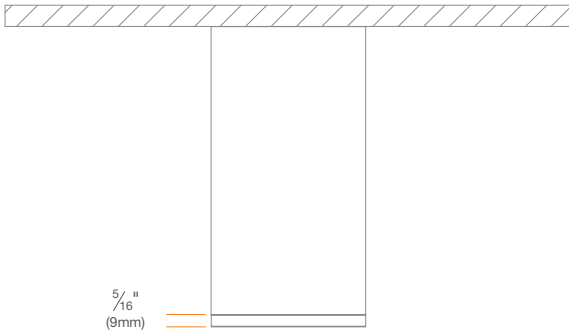

Snoot
DCCX-S

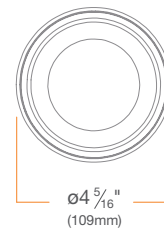
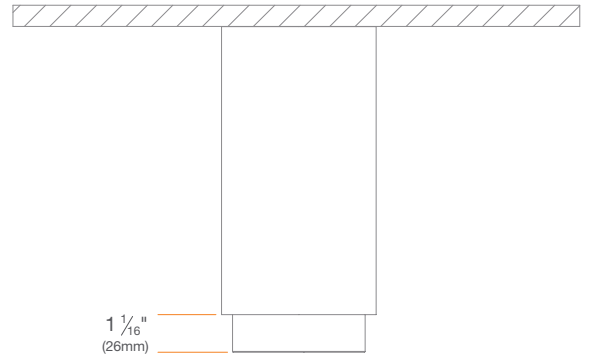

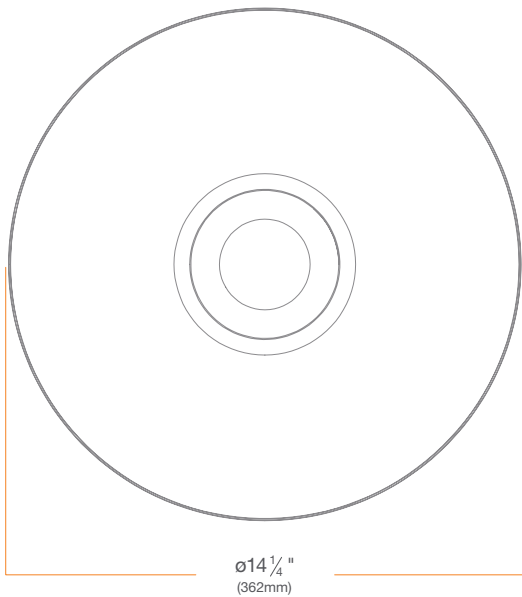
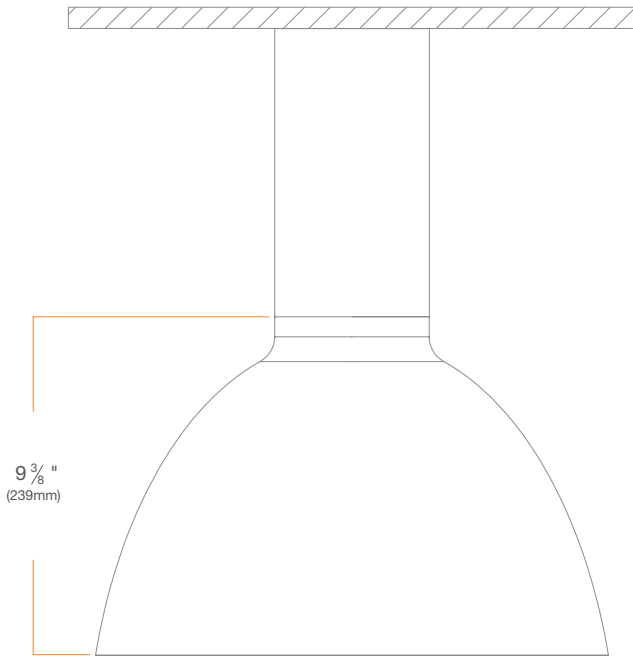
CYLINDER DIMENSIONS**Round Shade****DCCX-R****Flat Shade****DCCX-F**